

WONDER-GUN[®]

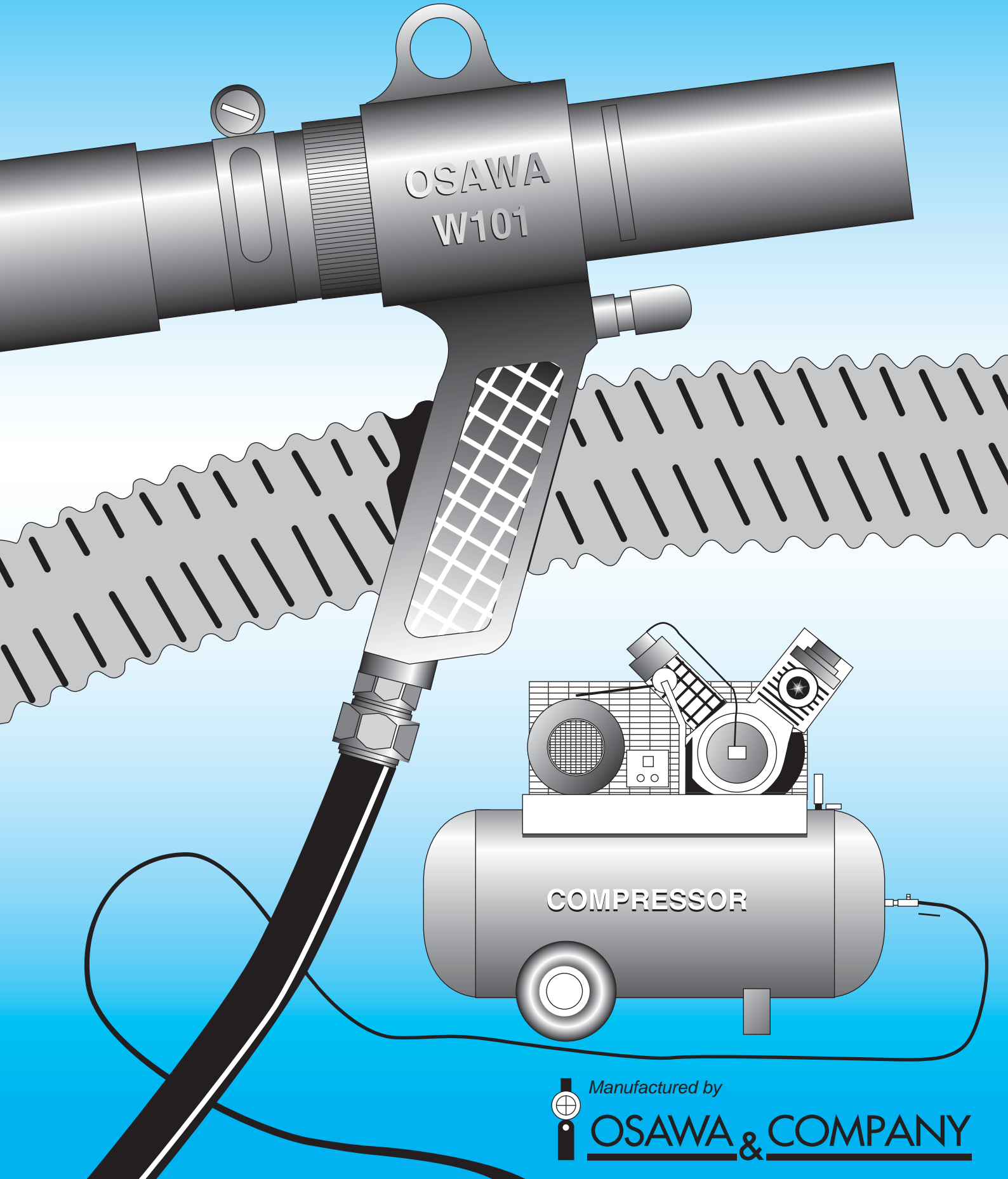

OSAWA
W101

COMPRESSOR

WONDER-GUN

Wonder-Gun is ...

a new type of air gun that uses compressed air to blow off, suction, and to transfer materials, and is used widely in many industries.

The products marked \bigcirc adopt the special jet system, which is a way of bringing out the full power of the compressed air. It works by injecting a large quantity of secondary air in angle to the main air jet and this causes the main air jet to spiral powerfully.

There are no worries that materials get clogged inside of Wonder-gun since it doesn't have any interior restrictions.

★ Wonder-Gun Hand Held Model W101 W301

Three in One (Blow off, Suction, Transferring)!!



Model	Specifications			
	Length	Minimum ID	Nozzle Orifice	Weight
W101	144	$\phi 22$	$\phi 1.4 \times 6$ holes	310g
W301	142	$\phi 11$	$\phi 1.4 \times 3$ holes	260g

We offer Powerful version for this model.

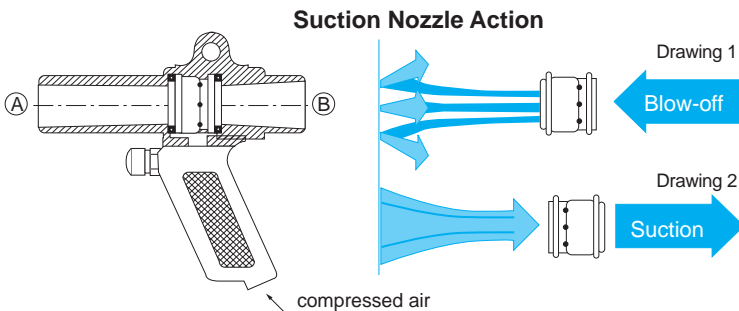
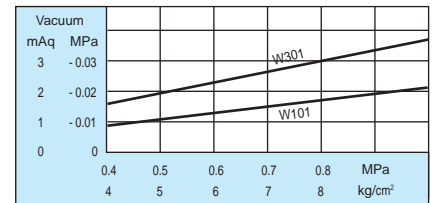
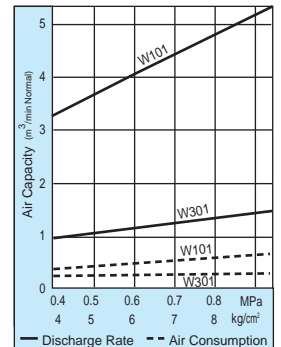

For Blow-off

Place the suction nozzle as in the left drawing 1. Then start operation. A large amount of air goes into the gun from side B together with the compressed air, and a strong air flow is blasted in spirals from the holes on the nozzle.

For Suction

Place the suction nozzle as in the left drawing 2. Then start operation. A large amount of air goes into the gun from side A together with the compressed air, and a strong air flow is blasted in spirals from the holes on the nozzle. In this operation, Wonder-gun can be used as a cleaner.

W101 A set For Suction

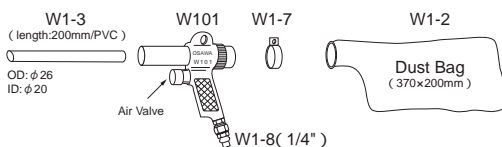

W101 B set For Suction

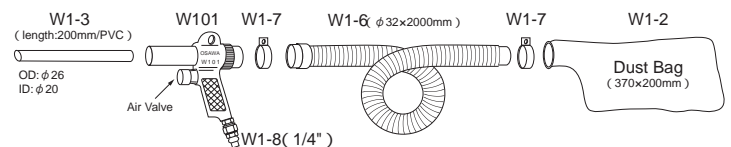

W301 A set For Suction

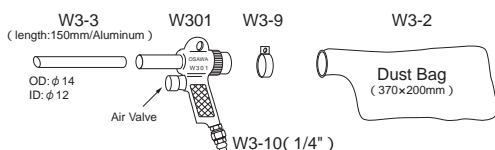

W301 B set For Suction

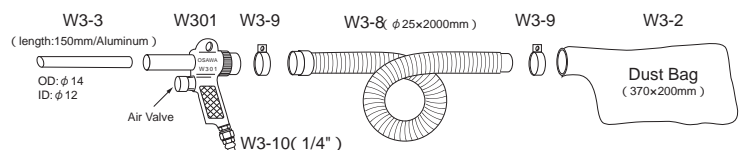

Example of use



WONDER-GUN

★ Wonder-Gun SS Model W101- -TH -TC -LC -LH

Mounting Model !!
Used Widely in Many Places!!

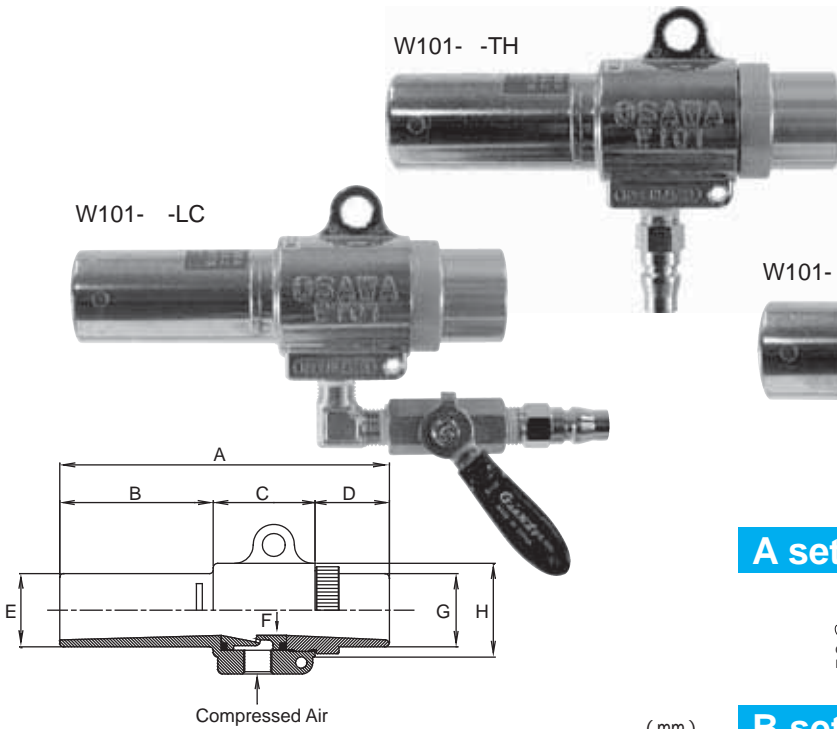

Model	A	B	C	D	E	F	G	H	Nozzle Orifice	Weight
W101-	144	67	44.5	32.5	32	22	32	41	φ1.4×6holes	250g

SS model has the same performance with Hand Held model; Hand Held model guns are altered to SS model. Please refer to performance chart on page (1). We offer Powerful versions.

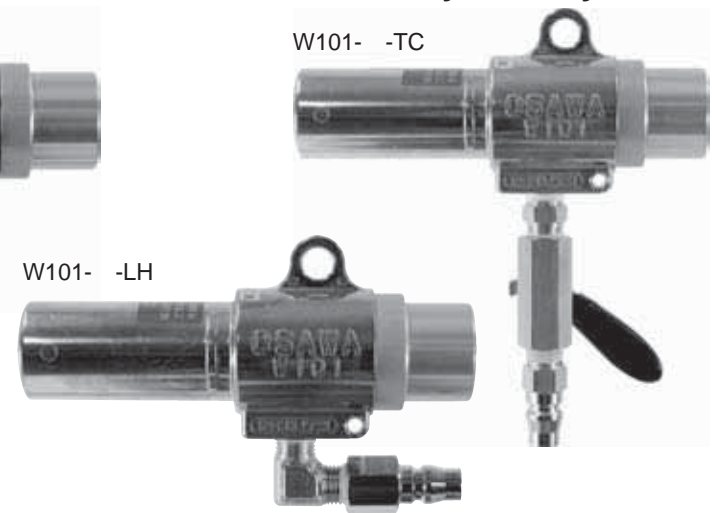

A set For Suction

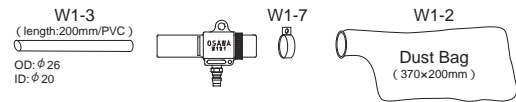

B set For Suction

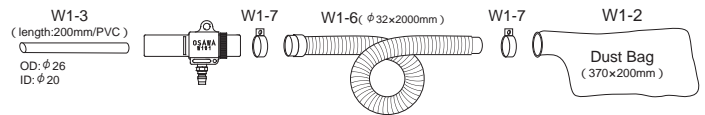

★ Wonder-Gun SS Model W301- -TH -TC -LC -LH

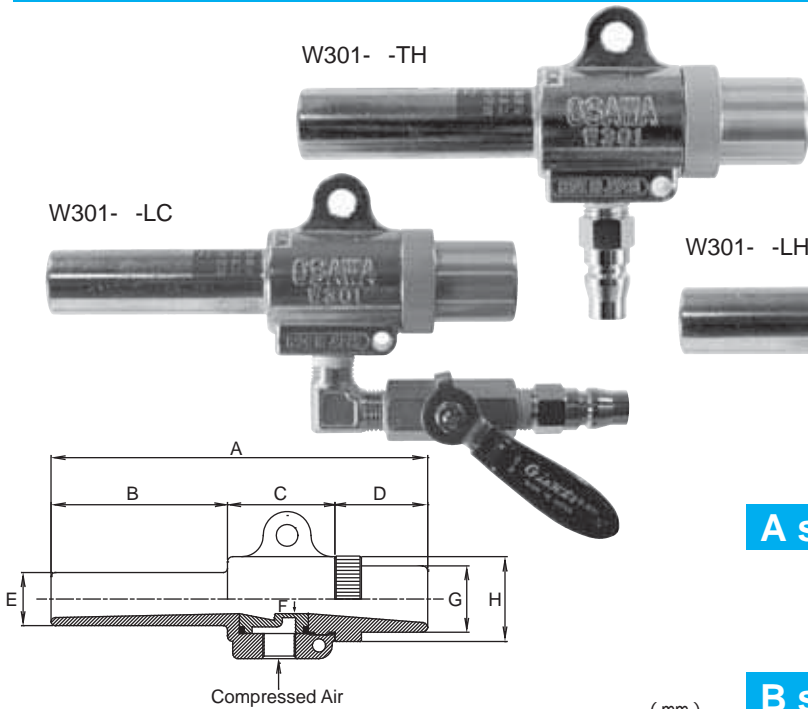

Model	A	B	C	D	E	F	G	H	Nozzle Orifice	Weight
W301-	142	66.5	40.5	35	20	11	25	32	φ1.4×3holes	175g

SS model has the same performance with Hand Held model; Hand Held model guns are altered to SS model. Please refer to performance chart on page (1). We offer Powerful versions.

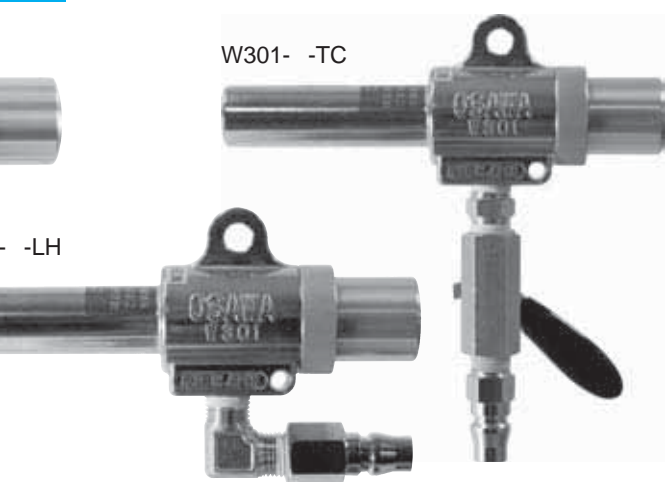

A set For Suction

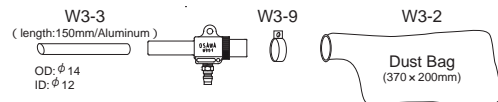

B set For Suction

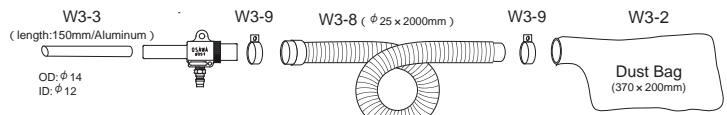

Example of use



WONDER-GUN

★ Wonder-Gun Jumbo Model J-38 J-50

Simple Structure!! Mounting Type!!

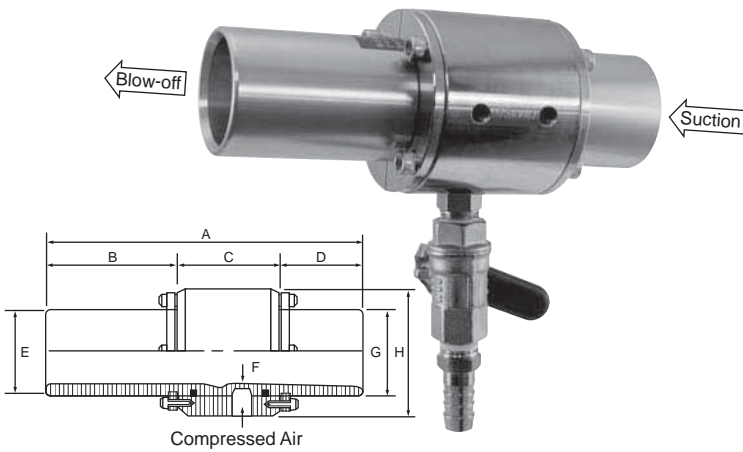

Recommended Compressors
 J-38: 10-15 Horse Power or more
 J-50: 20-25 Horse Power or more
 J-75: More than 35 Horse Power

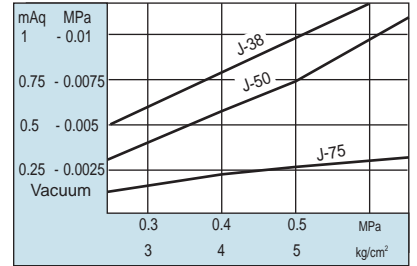
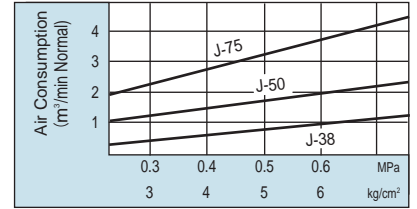
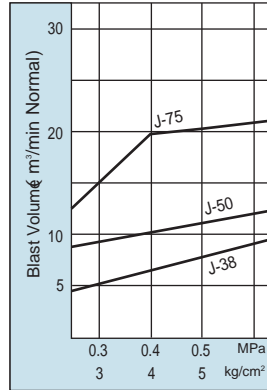

Model	A	B	C	D	E	F	G	H	Nozzle Orifice	Weight	Ball Valve	Air Connection	Mounting Holes (mm)
J-38	190	80	60	50	50	38	50	75	φ 1.6×12holes	1.8kg	3/8	1/2	M8×6
J-50	219	90	66	63	63	50	63	90	φ 2.3×12holes	2.5kg	3/8	1/2	M8×6
J-75	270	120	76	74	90	75	90	115	φ 2.3×24holes	4.0kg	1/2	3/4	M8×6

Because of small lot of production, Jumbo model becomes out of stock; Please confirm the delivery before you order.
 We offer hoses and dust bag specially for Jumbo model.

We offer powerful versions of Jumbo model.

Example of use



★ Wonder-Gun Mini Model W501-S NW501-S W501-L NW501-L

Compact!! Mounting Model !! Air volume is controlled with the rear knurled nut.

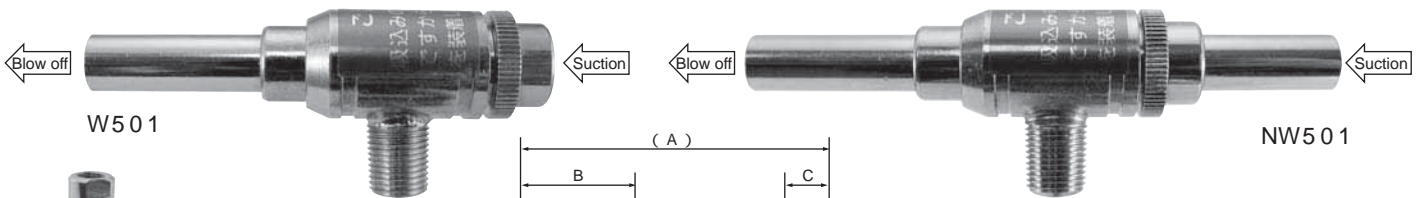

Model	A	B	C	D	E	F	G	H	I	K	Nozzle Orifice	Weight
W501-S	71.5	27	10	9	7	5	13.3	17	PT 1/8	10	φ 1.2×3holes	58g
W501-L	71.5	27	10	12	10	8	16.3	21	PT 1/8	13	φ 1.3×3holes	80g

We offer powerful versions; W501-SG (φ 1.2×6holes), W501-LG (φ 1.3mm×6holes)
 Total air blast and thrust increase 70% and suction force increases 50%.

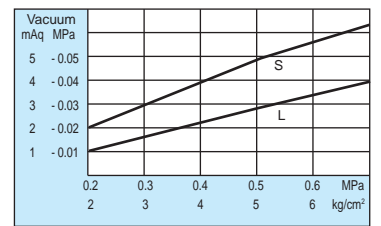

B set

For Suction

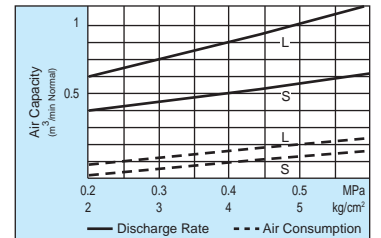
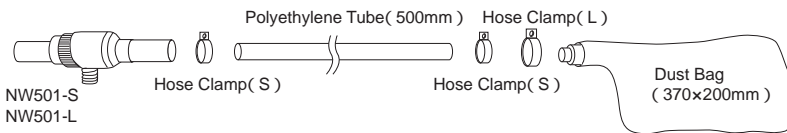

★ Wonder-Gun YW501 Model YW501-SG YW501-LG

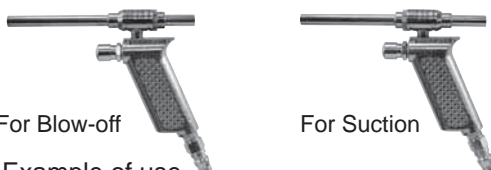

YW501 series are equipped with hand-grips.
 Please make sure to specify either suction or blow-off.

Air volume of YW501 series cannot be controlled with the rear knurled nut.
 Please control with regulator.

Please confirm delivery schedule since YW501 type are custom-ordered products.

Example of use



WONDER-GUN

★ Wonder-Gun Wide-Catch Model W101-YZ

**Draws in and Blow off
At the Same Time. How Clever!**



W101-YZ

Weight: 600g

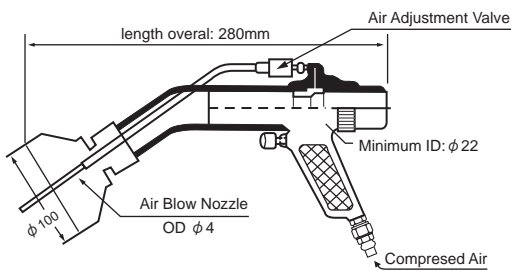

Features:

Air Blow Nozzle blows off materials and a Wide-mouth suction pipe never fails to catch them.

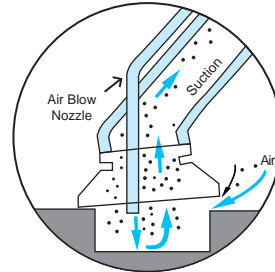

Plenty of Uses...

- Cleaning inside of wide-mouth bottles!
- Cleaning food containers!
- Removing chips from holes!

Don't seal completely!!

Requires outside air intake to work effectively.

- * Wonder-Gun Wide Catch model is provided as the unit below. Please order "W101-YZ Gun only" when you require only the gun.
- * Wonder-Gun Wide Catch can be used with Dust Collector PC-1 or W1-20.

Unit contains:

- W101-YZ Gun _____ 1
- φ 32 Duct Hose (2m) _____ 1
- Dust Bag _____ 1
- Hose Clamps _____ 2

Unit Contains

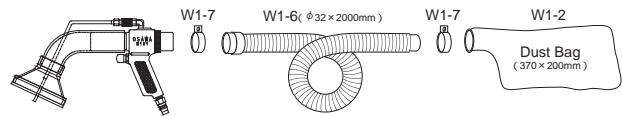

★ Wonder-Gun Wide-Catch Mounting model W101-YZ

- TH
- TC
- LC
- LH

W101-YZ-TH



W101-YZ-TC



W101-YZ-LC



W101-YZ-LH



A set

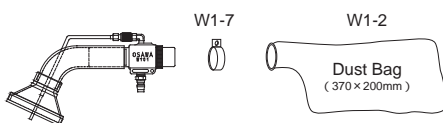

B set

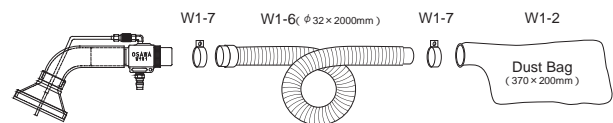

Wide-Catch Mounting model of is not a set; if you need a set, please order W101-YZ-LH-A or W101-YZ-LH-B.

■ These products are for special order. Please allow additional time for order assembly and delivery.

WONDER-GUN

★ Wonder-Gun Hole Cleaning Model W101-



W101-

● Wonder-gun Hole Cleaning Model can be used with Dust Collector PC-1 or W1-20.

★ Wonder-Gun Hole Cleaning Model W301-



W301-

● Wonder-gun Hole Cleaning Model can be used with Dust Collector PC-3 or W3-20.

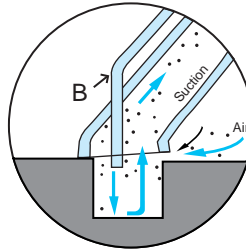
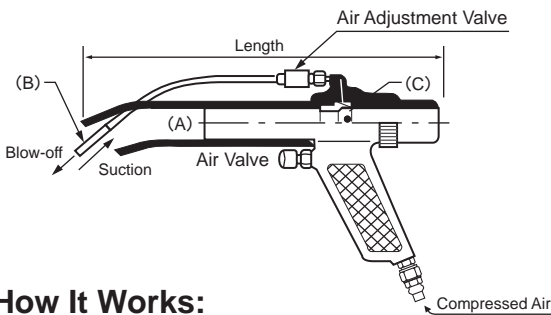

Wonder-gun Hole Cleaning Model is provided as the unit below. Please order "W101/301- Gun only" when you require only the gun.

Unit contains:

- W101/301- Gun ——— 1
- Duct Hose (2m) ——— 1
- Dust Bag ——— 1
- Hose Clamps ——— 2

Don't seal completely!!
Requires outside air intake to work effectively.

How It Works:

Put Air Blow Nozzle (B) into a hole and then press Air Valve. Air comes out from the nozzle, and blow dust off. The dust is cleaned by the Transparent pipe.

Model	Specifications (mm)						
	Length	Weight	ID (A)	Air Blow Nozzle OD (B)	Suction Nozzle ID (C)	Nozzle Orifice	Air Pressure
W101-	235	435g	φ 31	φ 5	φ 22	φ 1.4 × 6holes	0.4MPa (4kg/cm ² or more)
W301-	210	350g	φ 20	φ 4	φ 11	φ 1.4 × 3holes	0.4MPa (4kg/cm ² or more)

Cleans dust or chips in holes efficiently!!
Demonstrates great power in tapping!!

Unit Contains

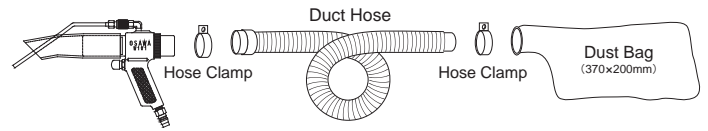

★ Wonder-Gun Hole Cleaning Mounting Model W101-

-TH -TC
-LC -LH

★ Wonder-Gun Hole Cleaning Mounting Model W301-

-TH -TC
-LC -LH

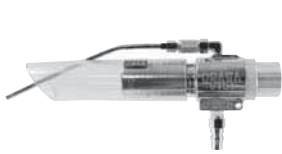

W101- -TH

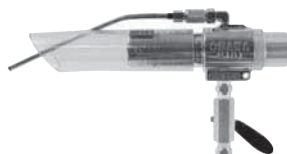

W101- -TC

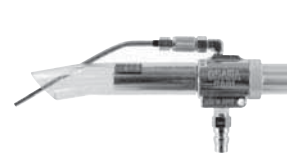

W301- -TH



W301- -TC

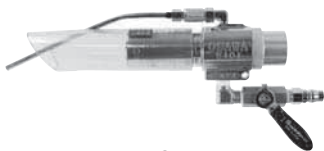

W101- -LC

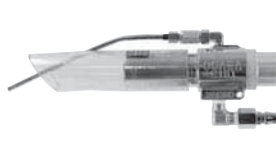

W101- -LH



W301- -LC



W301- -LH

A set



B set

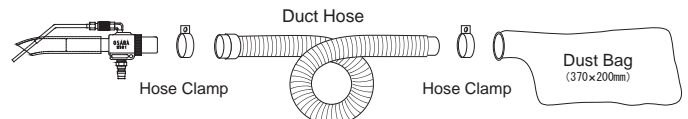

Wonder-gun Hole Cleaning Mounting model is not a set; if you need a set, please order W101- -TH-A or W101- -TH-B.

These products are for special order. Special orders may require more time to prepare and ship to the customer.

WONDER-GUN

★ Wonder-Gun Pencil Model W701



Feature

1. Compact and fits in your hand.
2. Can be used with low-pressure compressed air (0.15 ~ 0.5MPa(1.5 ~ 5.0kg/cm²)), thus safe and doesn't need much compressed air.
3. Suction pipe can be easily replaced for other uses.
4. There are no worries that materials will get clogged inside of Wonder- Gun due to a smooth walled interior constructure.

Example of use



Specification (mm)			
Length	ID	OD	Weight
140	φ 2.8	φ 20	60g

Small Size!!

Use as tweezers or for Cleaning in corners!!

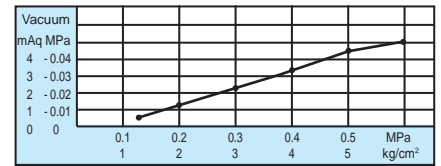

Unit contains:

- W701 Wonder-gun _____ 1
- 6x4 Air Tube 1.4m _____ 1
- (Equipped with 1/4" hose joint)
- 8x5 Tube for dust bag 0.4m _____ 1
- Nozzle _____ 1
- Dust bag _____ 5

Air Foot Valve FV-10

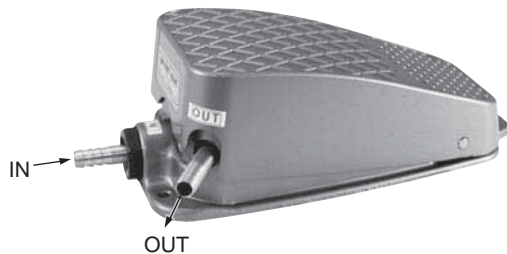

Length	Width	Height	Weight	Hose Joint
170	82	58	480g	1/4"

For Easy Pedal Operation !!

- 1 Strong Enough for Daily Use.
This product is made of aluminum die casting.
- 2 Easy Operation.
Use both hands free; Can be used with foot.
- 3 Simple Construction.
Air passes through smoothly so there are no breakdowns.

Air Foot Valve can be connected to W101/301 SS type, W501 series, W701, and other air tools as well.

Wonder-Gun Air Blast Model W301-ES-22 W301-ES-26

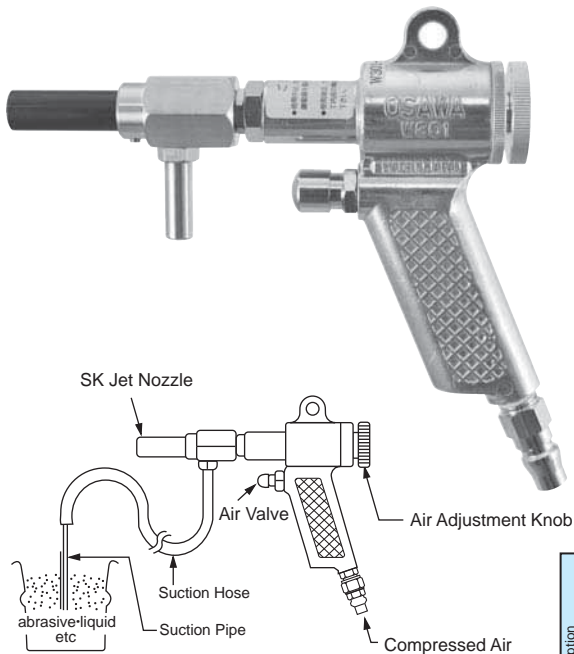

This can be remodeled to mounting type. Please refer to SS model on page (2).

Easily remove rust, scale and paint from parts and small equipment, leaving a satin finish ready for paint or further preparation. Air blast type sprays most abrasives including glass beads, aluminum oxide, steel grit, or liquids like oil. Draws abrasives straight from bucket or bag.

Air Pressure MPa (kg/cm ²)	Discharge per minute		Vacuum mEq(mm Hg) MPa
	Sand	Water	
0.4 (4)	800g	900cc	5.7(412) - 0.0577
0.5 (5)	850g	920cc	6.7(482) - 0.0675
0.6 (6)	850g	920cc	6.9(496) - 0.0695
0.7 (7)	850g	920cc	6.9(496) - 0.0695

Air Pressure MPa (kg/cm ²)	Discharge per minute		Vacuum mEq(mm Hg) MPa
	Sand	Water	
0.4 (4)	1800g	1820cc	6.1(436) - 0.0610
0.5 (5)	1800g	2000cc	6.2(446) - 0.0625
0.6 (6)	2000g	1710cc	6.1(436) - 0.0610
0.7 (7)	2000g	1500cc	5.8(416) - 0.0580

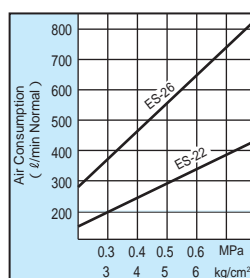

We offer a powerful version of air blast gun (W301-ES-28 with Jet Nozzle ID φ 10) Please contact us for detail.

Unit contains:

- W301-ES Air Blast Gun _____ 1
- Suction Hose(2m) _____ 1
- Suction Pipe(Iron) _____ 1

WONDER-GUN

★ Wonder-Gun Dust Collector W1-20 W1-20SET W3-20 W3-20SET



■ W1-20
Dust Collector
(Weight:6.7kg)



■ W3-20
Dust Collector
(Weight:6.7kg)

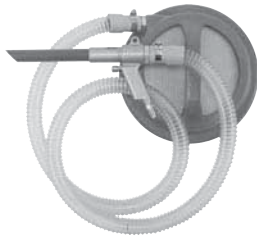

■ W1-20SET
Dust Collector Set
(Weight:7.7kg)

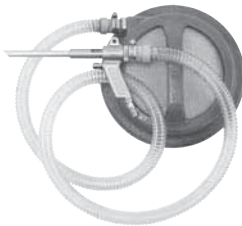

■ W3-20SET
Dust Collector Set
(Weight:7.4kg)

Unit Contains:

Model	Wonder-Gun	Suction Pipe	Hose(Oil Resistance)	Hose Clasps	Dust collector	Air coupler
W1-20 Set	W1011PC	φ 20 × 200mm 1PC	φ 32 × 2000mm 1PC	2PCS	W1-20 (φ 300) 1PC	1/4" 1PC
W3-20 Set	W3011PC	φ 12 × 150mm 1PC	φ 25 × 2000mm 1PC	2PCS	W3-20 (φ 300) 1PC	1/4" 1PC

The above products don't include any tanks.

Easy to Use!! For a Wide Range of Application!

W1-20 set and W3-20set series can be combined with 20ℓ tank. You can collect the materials which have been vacuumed by Wonder-Gun.

W1-20 can be combined with Wonder-Gun W101 series SS model, Wide-Catch model, and Hole Cleaning model.

W3-20 can be combined with Wonder-Gun W301 series SS model, and Hole Cleaning model.

We offer replacement filters.

Wonder-Gun Dust Collector series don't fit to handle liquid or powder. Please use Silent Cleaner or Mini Porter Cyclone for liquid and fine powder.

Please refer to page (1) for performance chart.

★ Wonder-Gun Dust Filter Dust Collector Super PC-1 PCS-1 PC-3 PCS-3



■ PC-1
Dust Filter
(Weight:6.5kg)



■ PC-3
Dust Filter
(Weight:6.5kg)



■ PCS-1
Dust Collector Super
(Weight:7.7kg)



■ PCS-3
Dust Collector Super
(Weight:7.4kg)

Unit Contains:

Model	Wonder-Gun	Suction Pipe	Hose(Oil Resistance)	Hose Clasps	Dust Collector	Air coupler
PCS-1	W101 1PC	φ 20×400mm 1PC	φ 32×2000mm 1PC	2PCS	PC-1	1/4" 1PC
PCS-3	W301 1PC	φ 12×300mm 1PC	φ 25×2000mm 1PC	2PCS	PC-3	1/4" 1PC

Please refer to page (1) for performance chart.

Easy to Move!! For a Wide Range of Application!

Equipped with a 20ℓ tank and aluminum stand with casters. Easy to move.

PCS-1 can be combined with Wonder-Gun W101 series SS model, Wide-Catch model, and Hole Cleaning model.

PCS-1 can be combined with Wonder-Gun W301 series SS model, and Hole Cleaning model.

We offer replacement filters.

Wonder-Gun Dust Collector series can't handle liquids or powders. Please use Silent Cleaner or Mini Porter Cyclone for liquids and fine powders.

SILENT-CLEANER

POWERFUL & SILENT

Silent Cleaner can handle water, oil, sludge, gravel, grain, metal chips and many more materials than other existing vacuum cleaners.

Built-in Silencer!!
Removable!!
Multiple Filters!!

★ Silent Cleaner

SC60-32S
 SC60-38S

Use for Hours of Continuous Operations!!

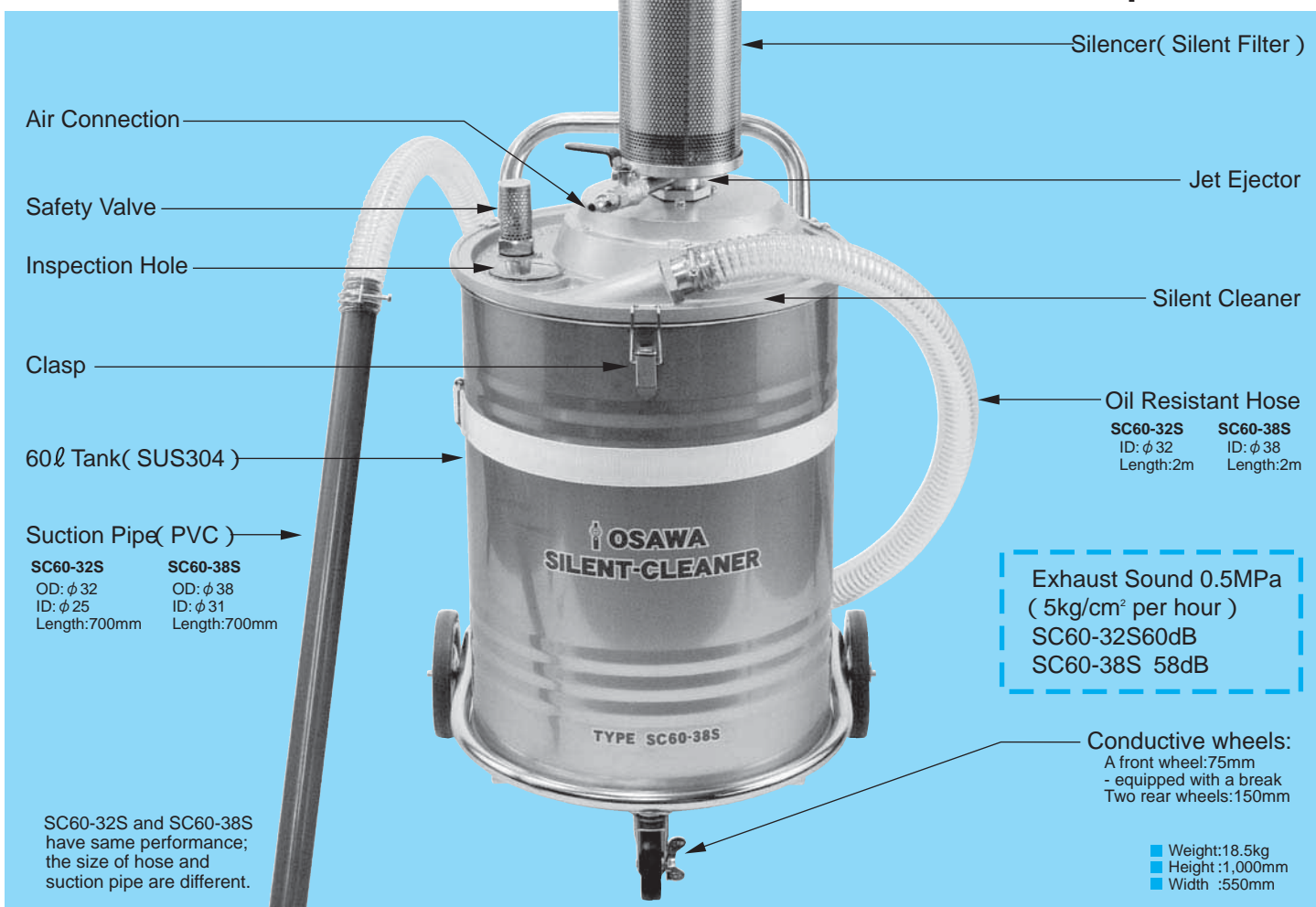

■ Performance Chart (SC60-32S, SC60-38S, SC200-32D, SC200-38D)

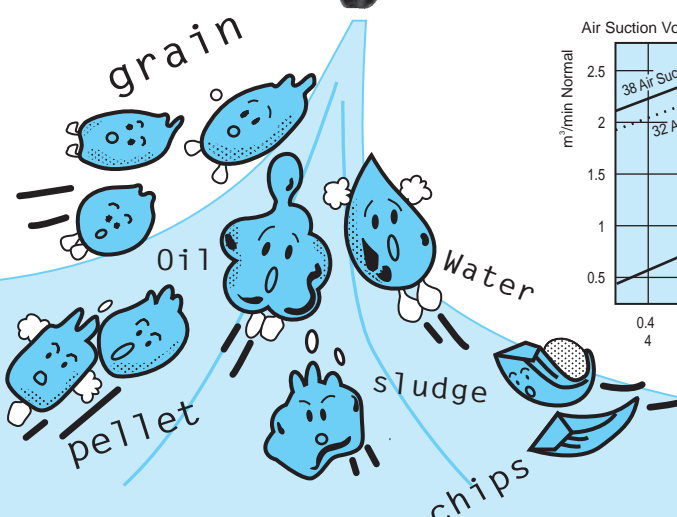

Air Suction Volume and Air Consumption

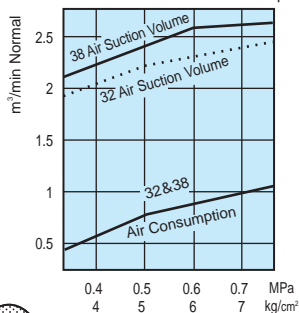

Wind Speed in Suction Pipe

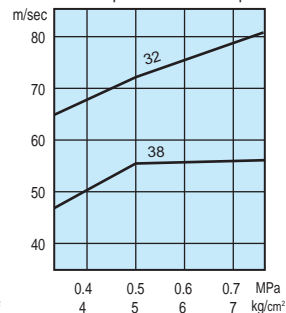

Vacuum

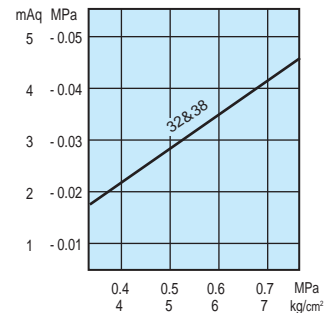

This data was collected when air valve was on full bore.

For fine powder, please use cleaners for fine powder.

SILENT-CLEANER

- **Jet Ejector**

Jet Ejector, the heart of the Silent Cleaner, is the device that creates strong suction. There are no rotating parts so no breakdowns.

- **Silencer**

The silencer keeps exhaust sound low - 60dB with SC30-32S.

- **Safety Valve**

Safety valve prevents sudden increase of vacuum and breakage of tank, which is caused by air pressure rise or hose obstruction.

- **Inner Filter**

Inside of Silencer, is glass-wool-made filter. This filter prevents dust from going outside. Please order "fine dust filter" for fine dust.

- **Powerful Models**

All Model can be custom ordered as Powerful models. Please put "G" at the end of model when you order. EX: SC30-32SG, SC60-38SG

☆ Silent Cleaner SC30-32S

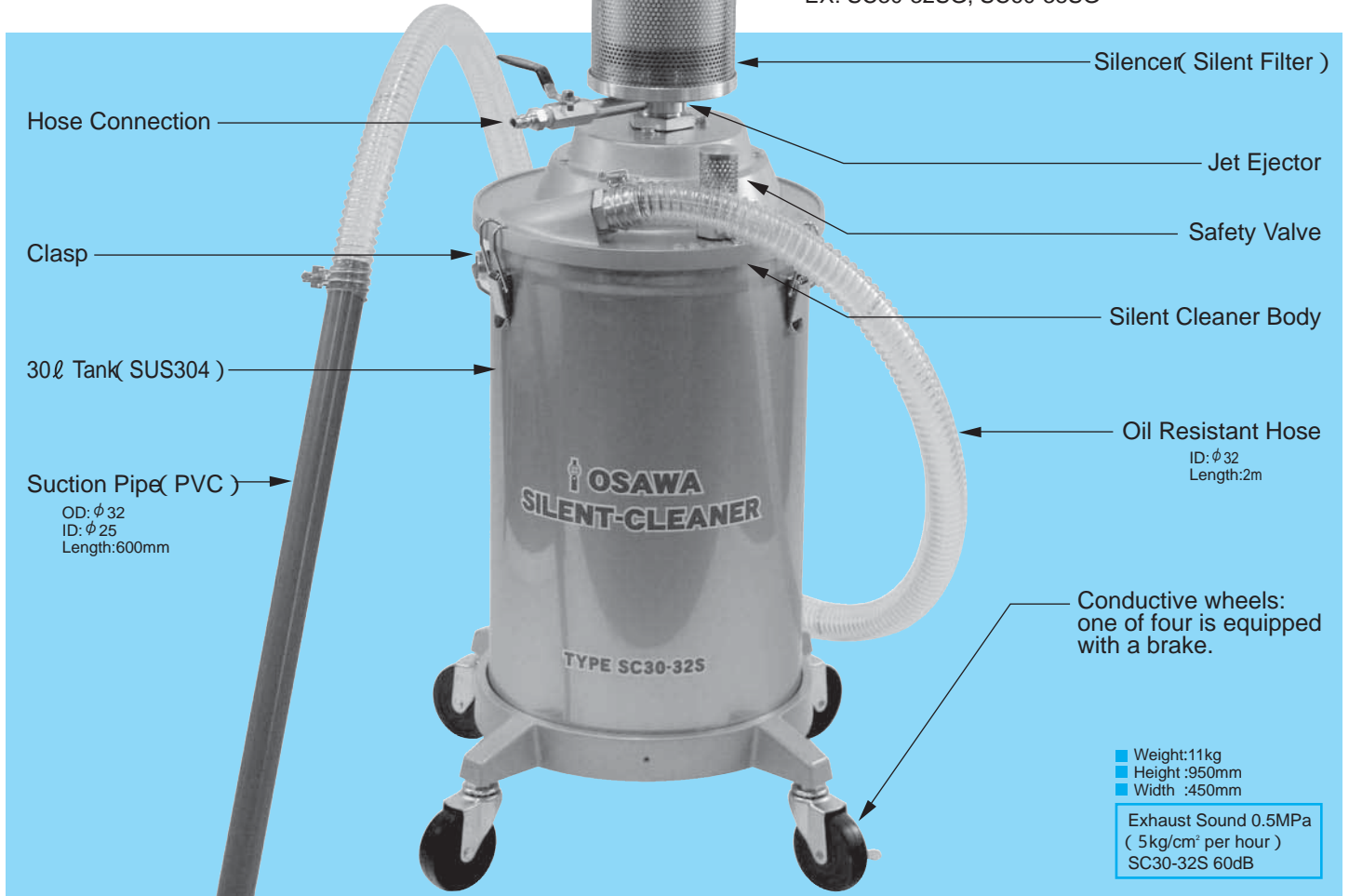

■ Performance Chart (SC30-32S, SC20-32, SC20-32P)

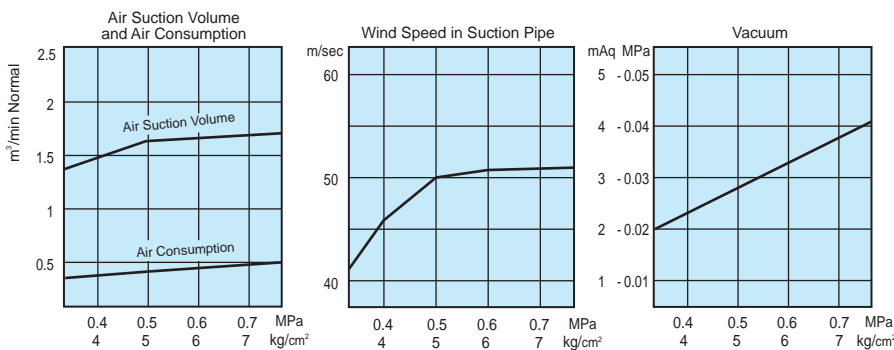

This data was collected when air valve was on full bore.

☆ SC20-32



SILENT-CLEANER

“Easy to Use ... Put it on a Tank !!!

★ We offer a powerful version for each model. Please put "G" on each number, such as SC20-32PG.



● Please put SC20-32P on a 20 l Tank.
For performance, please refer to performance chart on page (9).

Accessories (sold separately)



Please use Fine Filter for fine powder.



Hydro Stopper stops suction automatically when Silent Cleaner ingests certain amount of liquid.

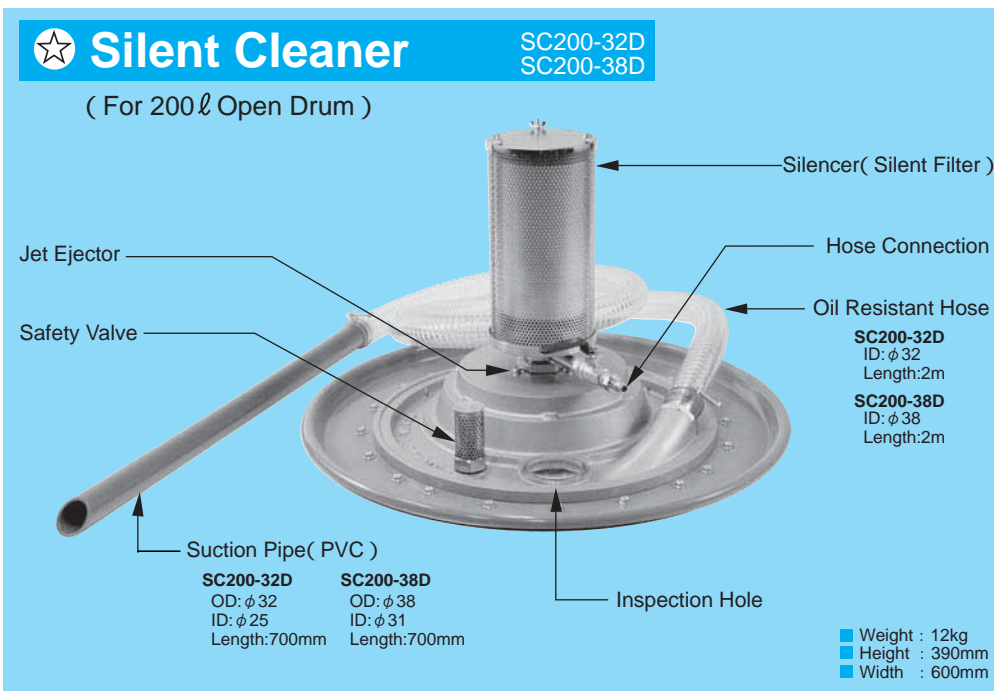

● Please put SC200-32D or SC200-38D on a 200 l open drum.
For performance, please refer to performance chart on page (8).



● Floor Brush



● Round Dusting Brush



● Narrow Nozzle

- We offer powerful versions of Silent Cleaner; ex: SC20-32PG, SC200-32DG.
- We offer Silent Cleaner for fine dust.

SC60-38SW/F	SC60-32SW/F	SC30-32SW/F	SC200-32DW/F
SC20-32W/F	SC20-32PW/F	SC60-50SW/F	SC200-38DW/F

- We recommend attaching Mini Porter Cyclone for a large amount of fine dust or powder.
- We offer Conductive Hose or Antistatic Hose.

SILENT-CLEANER

More POWERFUL than other models of Silent Cleaner!!!

Powerful !! and SILENT !!
 Cleans water, oil, sludge, grains, gravels and metal chips that other existing vacuum cleaners cannot.
 Recommended for any work place!

Twin Tower

★ Built-in Silencer!

★ Two-Tier System - Multiple Filters!

★ Use For hours of operation!

★ Silent Cleaner

SC60-50S

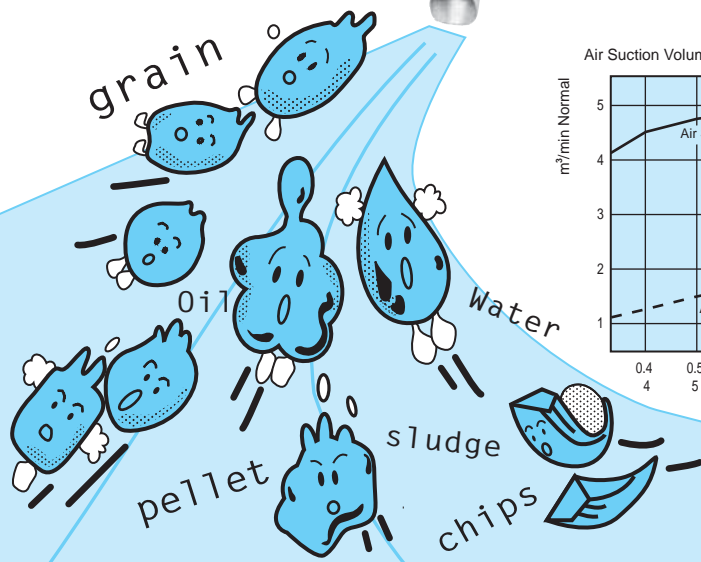
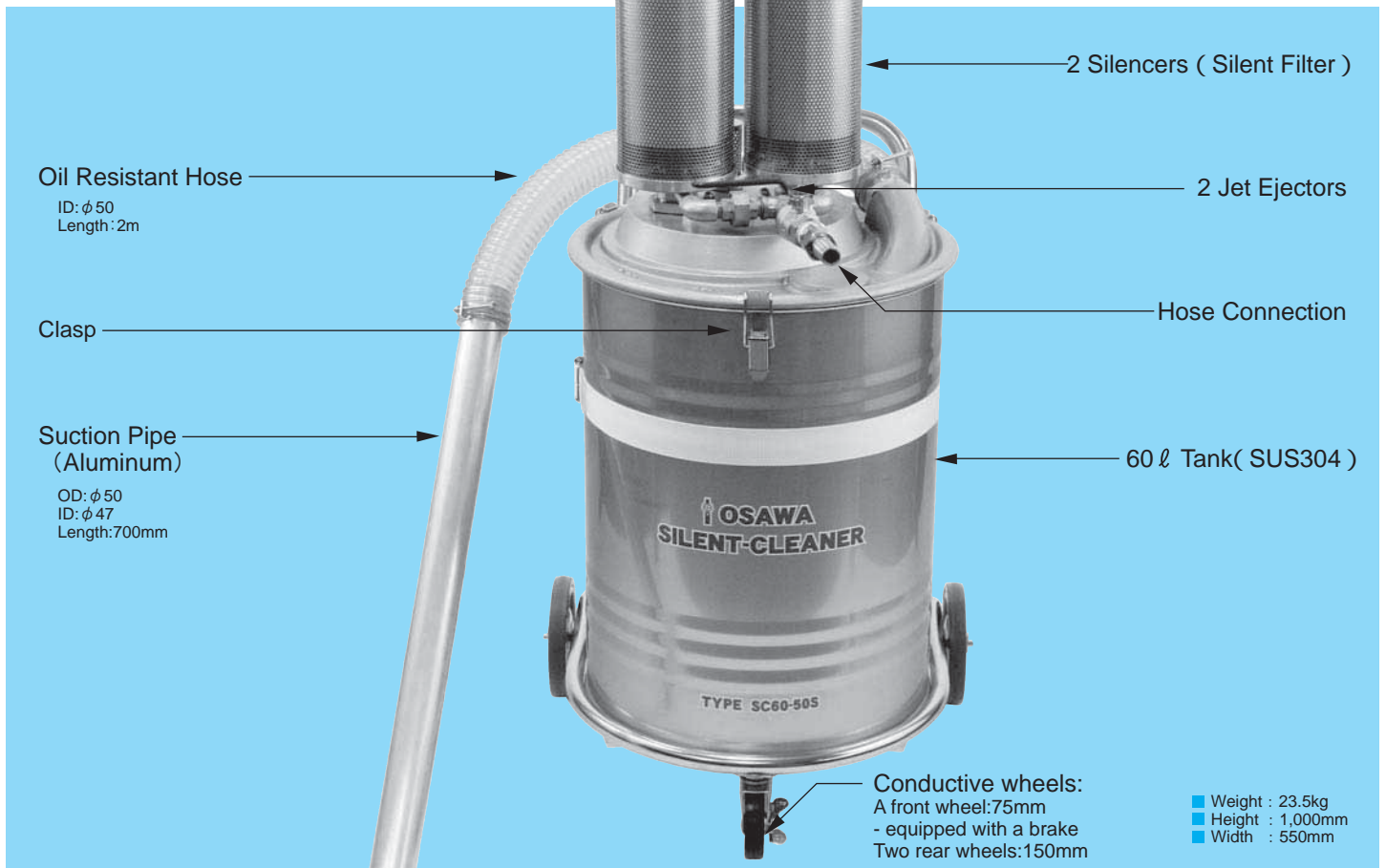

■ Performance Chart (SC60-50S)

Air Suction Volume and Air Consumption

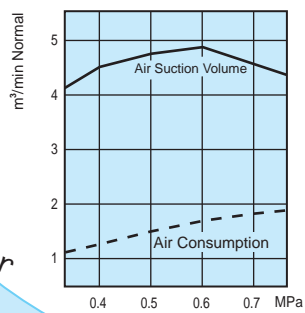

Wind Speed in Suction Pipe

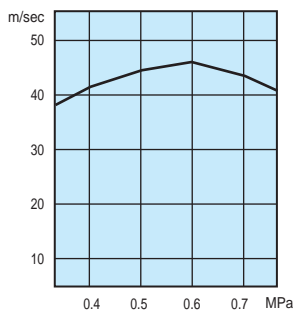

Vacuum

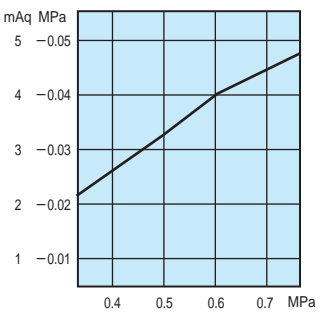

(This data was collected when air valve was on full bore.)

SILENT-CLEANER

**Vacuum Thick Materials
such as Mayonaise and Grease
EASILY !!**

Grease Model
- For high viscosity fluid

***Powered
by Compressor!!***

No Rotating Parts -
Breakdowns Caused by
Wear and Tear Are Minimized !!

★ Silent Cleaner

SC30-32TVG

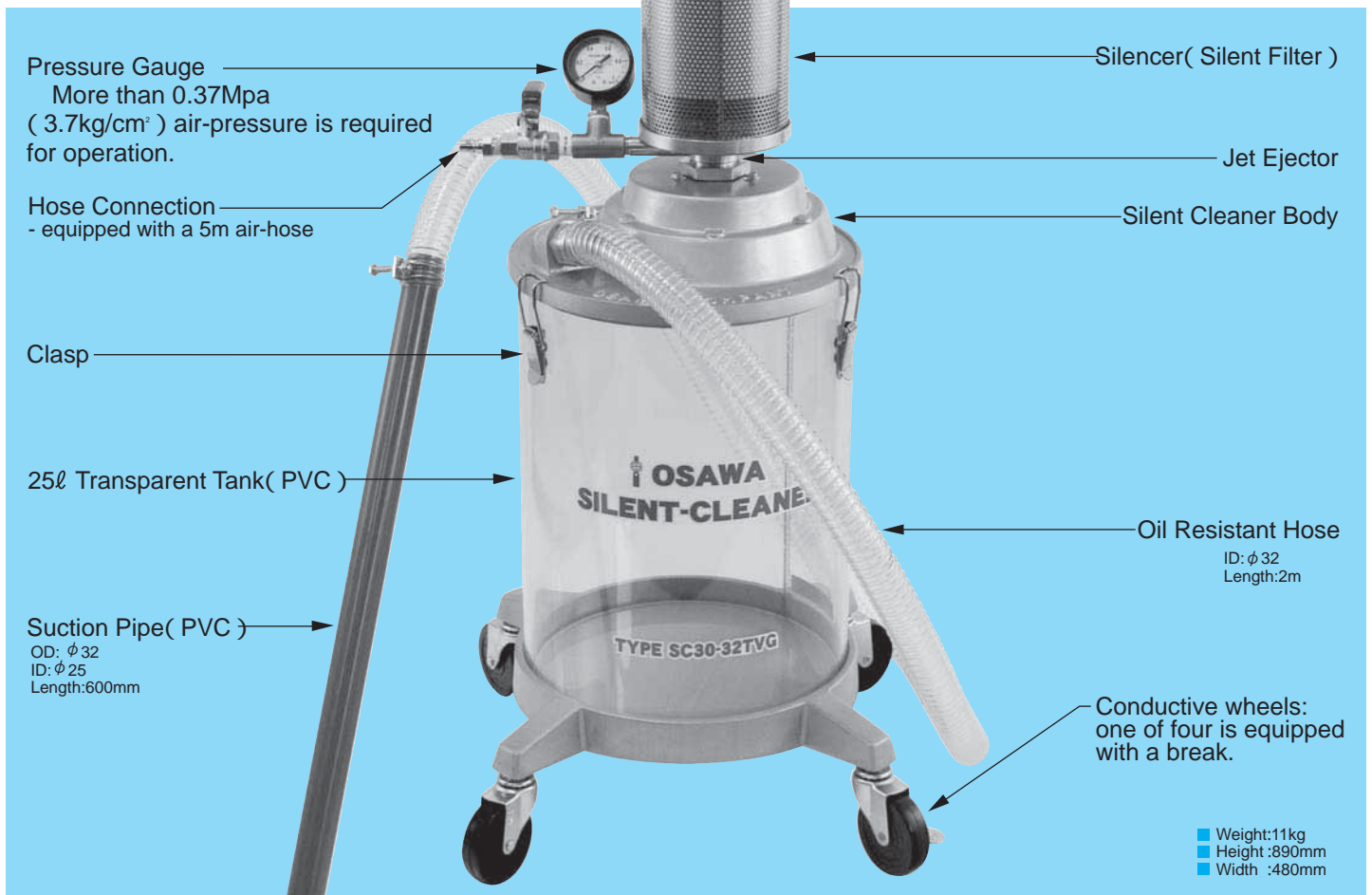

■ Performance Chart(SC30-32TVG,SC3T-19VG)

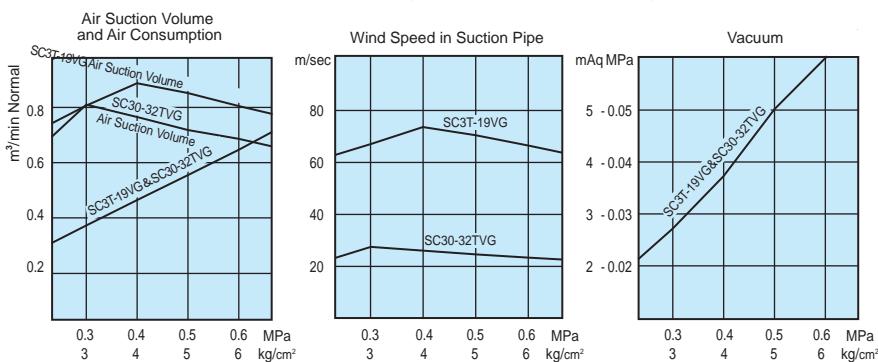

This data was collected when air valve was on full bore.

★ SC3T-19VG

(For highly viscious liquid)
Equipped with a 5 meter air hose

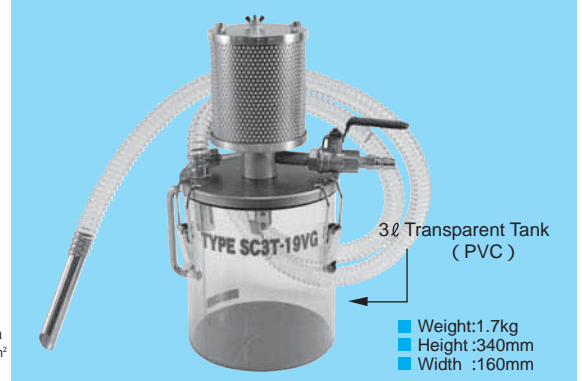

MINI-PORTER-CYCLONE

For Fine Powder and Dust ★No Filters!!

Mini Porter Cyclone

MP-38CF12 (PAT.)



Can be Connected to
ANY Vacuum cleaner!!
Easy to Move!!

Centrifugal Action of Mini Porter Cyclone

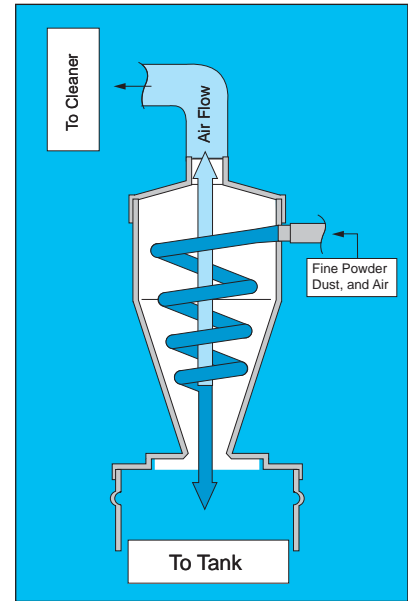

TROUBLES IN HANDLING FINE POWDER??

Mini Porter Cyclone separates powder and air by centrifugal force and sheer dead weight - with no filters. Eventually, the powder is dropped into a tank and accumulates while the air flows into the suction machine. When handling flour, for example, the efficiency is almost 100%. This function reduces maintenance and helps to save expense and time.

LIGHT AND COMPACT!!
Great for Cleaning
Office Automation Equipment -
Dust, Toner and stuff.

MP-19: The smallest in the Mini Porter series.
SC3T-19: The smallest in the Silent Cleaner series
Please refer to page (9) for the Silent Cleaner series.
Please contact us for further details.

Mini Porter Cyclone ★ Silent Cleaner

MP-19

SC3T-19

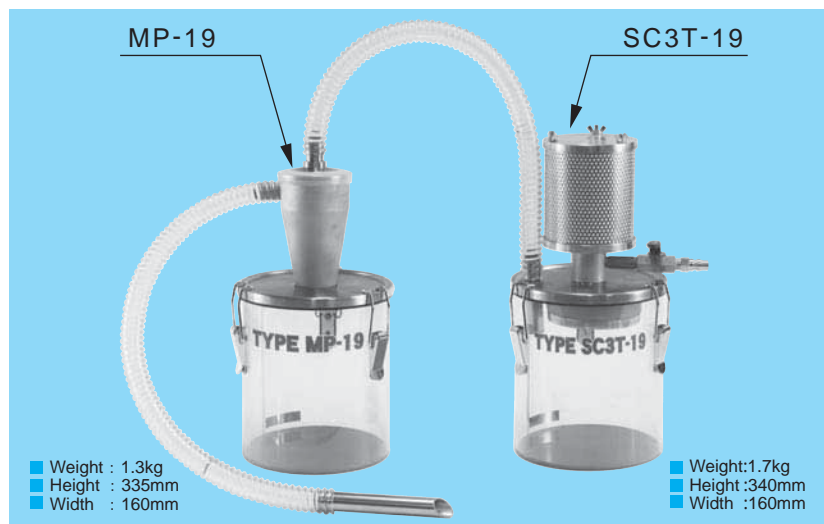

MINI-PORTER-CYCLONE

Built-in Jet Ejector!!

MP-38WA series are designed specially to handle fine powder.

No Filters

are used to process fine dust or powder.

No Rotating parts -

Breakdowns caused by wear and tear are minimized.

(Same construction as Silent Cleaner)

★ Mini Porter Cyclone with Ejector MP-38WACF12

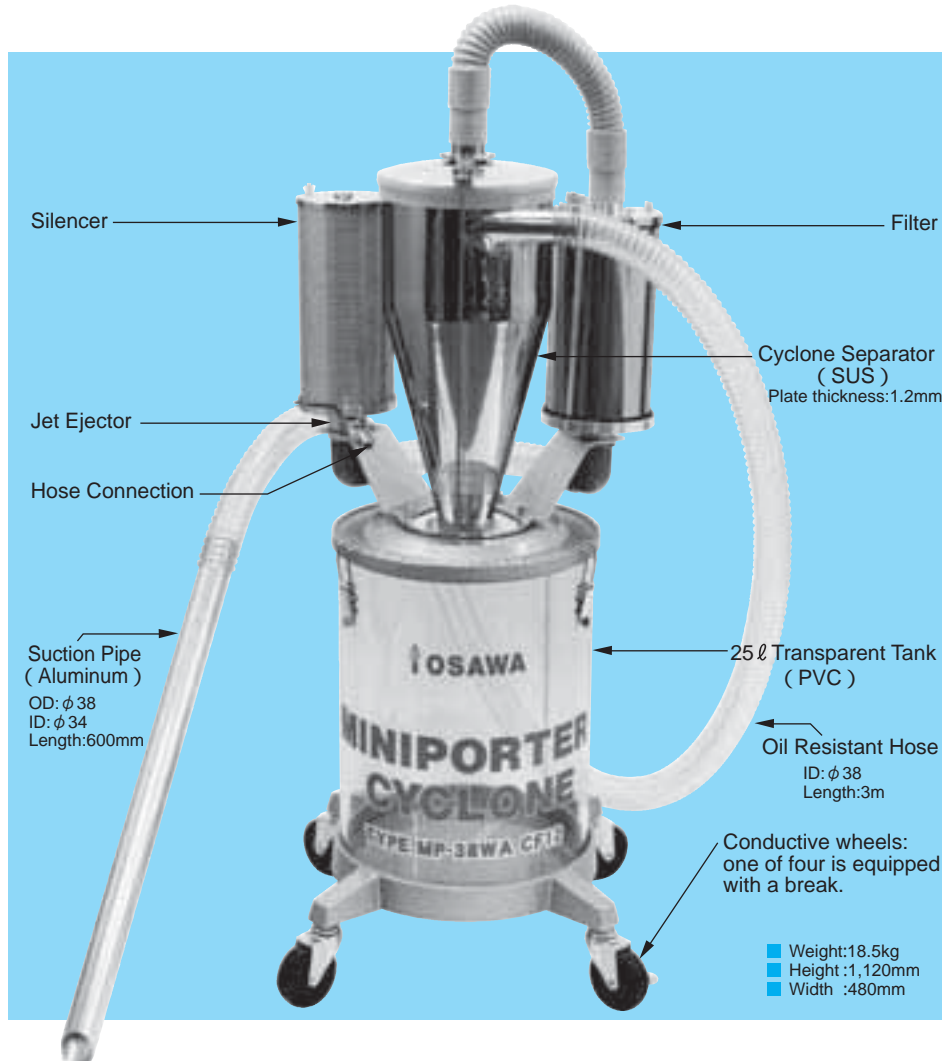

★ Combination Model



Combination Model
(ex: MP-38SCF12&SC30-32SW/F)
Easy to Move!! Great for Fine Powder!!

■ Performance Chart (MP-38WACF12)

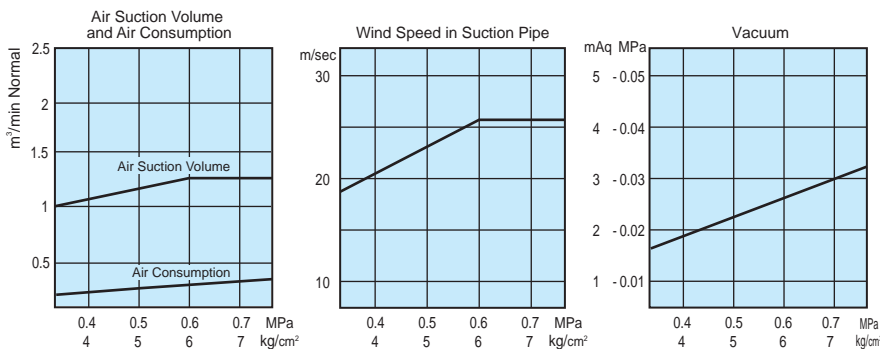

This data was collected when air valve was on full bore.

Mini Porter Cyclone series

- MP-38CF12 - Plate Thickness 1.2mm Hose ID ϕ 38
- MP-38CF20 - Plate Thickness 2.0mm Hose ID ϕ 38
- MP-50CF12 - Plate Thickness 1.2mm Hose ID ϕ 50
- MP-50CF20 - Plate Thickness 2.0mm Hose ID ϕ 50
- MP-38WACF12 - Plate Thickness 1.2mm Hose ID ϕ 38
- MP-38WACF20 - Plate Thickness 2.0mm Hose ID ϕ 38
- MP-50WACF12 - Plate Thickness 1.2mm Hose ID ϕ 50
- MP-50WACF20 - Plate Thickness 2.0mm Hose ID ϕ 50

For custom-orders, please contact us.